





IMPORTANT

The latest operating manuals and parts catalogues are available on our website:
<http://www.metalfach.com.pl/en/materialy-do-pobrania>

TRAILER DATA:

Vehicle type:		Farming truck trailer
Commercial designation:		T710
Type designation:		T710/1, T710/2 *
Trailer identification number ^{1/} :	
Trailer manufacturer:		"METAL-FACH" Sp. z o. o. 16-100 Sokółka, Poland ul. Kresowa 62 Tel. no. +48 85 711 98 40 Fax: +48 85 711 90 65
Sold by:	Address:
	Tel./Fax
Date of delivery	
Owner / User	Full name
	Address
	Tel./Fax

**IMPORTANT**

Hint: Please note down the tipper truck type and serial number - it will be required for contact with your authorised dealership.

^{1/} The data is found on the trailer nameplate located on the trailer chassis front crosspiece
*delete as appropriate

TABLE OF CONTENTS

1.	INTRODUCTION	5	6.	OPERATION INFORMATION	21
1.1.	Intended uses	5	6.1.	Commissioning the trailer	21
1.2.	Equipment	5	6.2.	Loading the body	21
1.3.	Machine identification	7	6.3.	Travelling on public roads	22
2.	GENERAL SAFETY RULES	8	6.4.	Unloading	22
2.1.	Symbols and nomenclature	8	6.5.	Decoupling from the tractor	24
2.2.	Obligatory notification	8	7.	SERVICING	24
2.3.	General safety regulations on work and use	8	7.1.	Servicing instruction for adjusted trailer components	24
2.3.1.	Safety of operation	9	7.1.1.	Wheels – bearing clearance adjustment	24
2.3.2.	Tyres	10	7.2.	Brakes	25
2.3.3.	Pneumatic system	10	7.2.1.	Servicing the brake pneumatic system	25
2.3.4.	Periodic maintenance	10	7.2.2.	Adjustment of the braking system components	25
2.3.5.	Travelling on public roads	11	7.3.	Wheels – tyres	26
2.4.	Warning/information signs and text on the trailer	11	7.4.	Hydraulic system	27
3.	TECHNICAL CHARACTERISTICS, GENERAL DATA	14	7.4.1.	Servicing of the load body hydraulic tipping system	27
4.	GENERAL DESCRIPTION OF DESIGN AND FUNCTION	17	7.4.2.	Servicing of the load body hydraulic tipping system	27
4.1.	Chassis	17	8.	TROUBLESHOOTING	28
4.2.	Loading space	17	9.	PERIODIC MAINTENANCE	29
4.3.	Load body hydraulic tipping mechanism	17	9.1.	Lubrication	29
4.4.	Electrical system (signalling and warning)	18	9.2.	Maintenance and servicing	29
4.5.	Braking system	18	10.	DISPOSAL OF THE TRAILER	30
5.	STORAGE, SALE AND SHIPPING TO USER	20	11.	RESIDUAL RISKS	30
5.1.	Storage	20	11.1.	Description of residual risks	30
5.2.	Sale	20	11.2.	Evaluation of the residual risk	30
5.3.	Shipping to user	20	12.	WARRANTY CONDITIONS	31

1. INTRODUCTION

These Operating Instructions are intended to provide the product user with information concerning operation, servicing and maintenance of the machine. They contain operating performance data and the requirements for safe and professional operation of the machine which enable the best use of the product with the maximum operating life and reliability. They also contain information about ordering spare parts. Thorough understanding of the Operating Instructions will help the user prevent accidents, operate the machine efficiently and keep the warranty valid. Unauthorised modification of the trailer design may release the manufacturer from liability for resulting damage and loss.

METAL-FACH Sp. z o. o. reserves the right to introduce changes without prior notice and without assuming any obligations resulting from those changes.

ALL OPERATORS OF THIS TRAILER MUST UNDERSTAND THE CONTENTS OF THE OPERATING INSTRUCTIONS BEFORE COMMENCING WORK. THE MANUAL IS A PART OF THE T710 TRAILER'S ESSENTIAL EQUIPMENT.

This is intended to maintain proper operation of the trailer, safety of use and maximum operating life. This is also the condition which ensures that your warranty rights are maintained.

1.1. INTENDED USES

The trailer is intended for transport of crops and other bulk or loose materials within a farm and on public roads. The trailer is unloaded manually or by tipping the load body to the rear or to the sides. The trailer is designed for coupling with farming tractors of varying power ratings, equipped with an external power hydraulic system, a power outlet for the electrical lighting and warning systems and the braking system of hitched machines, and a transport hitch.

- Do not use this trailer to carry fuel, gas cylinders and similar due to the compliance requirements for transport of hazardous materials.
- Do not use the trailer to transport: fuel, gas cylinders, or toxic materials that may cause environmental pollution. The manufacturer shall not be liable for any resulting damage as it is solely incurred by the owner.
- The trailer shall only be used by persons who have understood the operating manual and who have been trained in hazards and first aid for accident victims.
- Follow all applicable laws for accident prevention and any other recognised rules of engineering safety, work medicine and road traffic safety.
- The manufacturer shall not be liable for damage from any unauthorised modifications of this trailer's design.

1.2. EQUIPMENT

The basic equipment of each trailer includes:

- Operating instructions manual;
- Warranty card with warranty conditions;
- Bracket for the sign "slow-moving vehicle";
- The two-line pneumatic brakes with adjustable braking force (single-line system is available on request);
- Parking brake;
- Lighting installation;
- Semi-elliptic spring suspension;
- Folded walls, front and rear.

On customer's request (additional costs incurred), the manufacturer may equip the trailer with the slow-moving vehicle sign and a reflective warning triangle.



CE DECLARATION OF CONFORMITY



FOR THE MACHINE

METAL-FACH Sp. z o.o.
ul. Kresowa 62
16-100 SOKÓŁKA

acting as the manufacturer

declares under sole responsibility that the following machine:

Farming truck trailer
type/model: T710
serial number:
year of manufacture:.....

this declaration concerns, meets the following requirements:

- **Directive 2006/42/EC OF THE EUROPEAN PARLIAMENT AND OF THE COUNCIL** dated May 17th, 2006 on machines and the **Resolution of the Minister of Economy** of October 21st, 2008 concerning general requirements for machinery (Journal of Laws, issue 199 item 1228);

The following harmonised standards were used for compliance evaluation:

PN-EN 1853+A1:2009E	PN-EN ISO 13857:2010P
PN-EN ISO 4254-1:2009E	PN-EN ISO 12100:2012P

- and the following standards: PN-ISO 3600:1998, PN-ISO 11684:1998; and the Resolution of the Ministry of Infrastructure of 31 December 2002 on technical requirements for vehicles and the scope of their necessary equipment (Journal of Laws 2003 no. 32 item 262 as amended).

Safety Test Report no. ZE/81/09

Unit responsible for engineering documentation: Metal-Fach Engineering Department

This Declaration of Conformity becomes void and null if the machine design is changed or modified in any manner without prior consent from the manufacturer.

Sokolka,

President of the Management Board

Jacek Marek Kucharewicz

1.3. MACHINE IDENTIFICATION

In all correspondence, questions, and warranty issues, please state the type and identification number of the trailer.

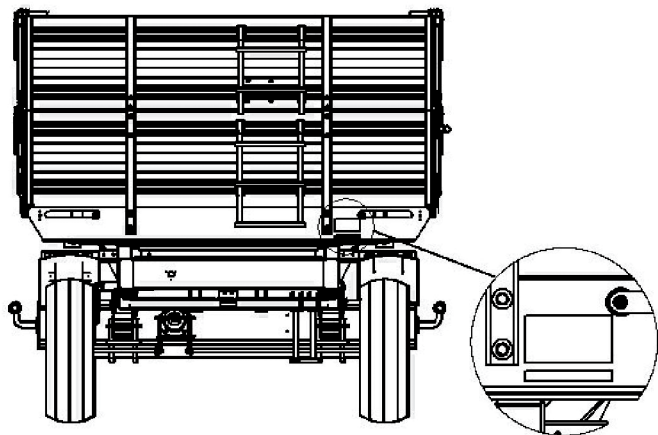

The identification data is found on the trailer nameplate located on the trailer chassis front crosspiece. The trailer's serial number is stamped on the nameplate and under the plate, directly on the machine frame.

THE MANUAL IS A PART OF THE TRAILER'S ESSENTIAL EQUIPMENT.

METAL - FACH Sp. z o.o. ul. Kresowa 62 16-100 Sokółka, Poland tel. +48(085)711 98 40 www.metalfach.com.pl			
Typ/Wariant	<input type="text" value="T710/1"/>	Masa własna	<input type="text" value="2000"/> kg
Data prod.	<input type="text" value="20"/>		
Nr fabr.	<input type="text" value="T71011"/>	KJ	<input type="text"/>
Nr świadectwa homologacji	<input type="text"/>		
Dopuszczalna masa całkowita	<input type="text" value="8000"/>		kg
Dopuszczalne obciążenie osi	<input type="text" value="40/40"/>		KN





WARNING!

It is forbidden to drive the trailer on public roads or operate the trailer without its nameplate or with an illegible nameplate.

2. GENERAL SAFETY RULES

2.1. SYMBOLS AND NOMENCLATURE

	Failure to comply with these guidelines may result in damage of equipment or its components.
IMPORTANT	

	This warning sign in the operating instructions means that special caution shall be exercised due to hazards to persons and potential damage to the product.
WARNING!	

	It is important to carefully follow these notes or guidelines.
NOTE!	

Qualified persons are persons who perform the required tasks by always using their education, experience and training, as well as their understanding of standards, definitions, accident prevention regulations and operating conditions; hence they are also capable of identifying and avoiding potential hazards. Among others, these persons are also required to understand first aid measures for the injured (e.g. by wounding). The term "operation" includes settings, starting (preparation for use) and operation (starting, commissioning, powering off, etc.). The term "maintenance of proper condition" includes checks and care (control, adjustments), servicing and repairs (troubleshooting).

Note all other (specially highlighted) indications, such as:

- Transport;
- Assembly;
- Operation;
- Servicing;
- Technical data (in the operating instructions, production records and on the trailer itself).

It is all the same essential due to the potential (direct and indirect) hazards and their consequences being severe damage of human health and property.

2.2. OBLIGATORY NOTIFICATION

When the trailer is transferred to another user, the operating instructions shall be transferred as well, whereas the receiving user must undergo training according to the instructions.

2.3. GENERAL SAFETY REGULATIONS ON WORK AND USE

Before each start of work, inspect the trailer for work safety.

1. Aside from the guidelines in these operating instructions, follow the general regulations for safety and accident prevention.
2. The affixed information and warning signs and text indicate important guidance for safe operation. Follow it for your own safety.
3. Start the trailer only when all required equipment is connected and secured against unintended release or opening (e.g. the hitch and tow bar system, couplings, etc.).
4. Understand all equipment and controls, as well as their functions, before work. It is too late to learn that during work.
5. The trailer must not be used by persons who are under the influence of alcohol and/or other substances, and/or not trained or suitably licensed to operate motor vehicles.

2.3.1. SAFETY OF OPERATION

1. All work safety information shall be given to all other users of the trailer.
2. Check the direct environment (for children and bystanders) before start. Pay particular attention when visibility is poor.
3. Do not remain on the trailer in motion, while coupling the trailer with a tractor and loading or unloading the trailer.
4. After unloading the trailer, lower the load body completely. Never leave the trailer unattended with its load body raised.
5. Enter the trailer only when it has completely stopped and with the tractor engine stopped.
6. Lift and lower the load body only from the driver's seat.
7. Hitch the trailer according to regulations, couple only with recommended equipment and secure the tow bar hitch-ring to the tractor transport hitch.
8. Exercise extreme caution when coupling/decoupling the trailer with/ from the tractor.
9. When installing and removing supports, security/safety equipment and ladders, always position them to ensure safety to operators.
10. Follow the maximum permissible axle loads, total weight and transport dimensions.
11. Do the following checks: coupling and functional test of brakes and lights, inspect the slow-moving vehicle sign, and check other protective devices.
12. Do a functional test of lights and brakes before driving. Also prepare the trailer as recommended in Section "Travelling on public roads".
13. Mind the changes in vehicle behaviour, steerability and braking efficiency due to the hitched trailer and its load.
14. When towing the trailer, mind the layout of loads and/or inertia, especially when the load is unevenly distributed.
15. Do not remain within the range of a load being discharged.
16. Start the hydraulic lift (tipping) of the load body only when:
 - the trailer is coupled with the tractor, AND
 - the trailer is parked on a hard and level ground, AND
 - no persons remain in the unloading area, AND
 - when the tractor's axis is aligned with the trailer, AND
 - the machines are at a safe distance from all power lines, AND
 - there are no strong gusts of wind.
17. If it is necessary to unload to the rear while parking on a slope, the trailer with the tractor must be parked in the uphill direction. If unloading to the side on a slope, tilt the load body to the side opposite to the trailer's direction of gradient.
18. During all work with the load body raised, secure it against falling with the support delivered with the trailer. Turn off the tractor engine and remove the ignition key.
19. Be careful to avoid crushing of fingers and hands during opening and closing of the load body walls.
20. Mind the warnings of crush and cut hazard areas when starting the work with trailer. There is a risk of injury when coupling/decoupling the trailer with/from the tractor. When coupling/decoupling, do not enter between the trailer and the tractor or stand behind the trailer if the trailer is not secured with wheel chocks or the parking brake.
21. No person is allowed to remain between the trailer and the tractor if the vehicle is not secured against rolling with parking brake and/or wheel chocks.
22. When parked, secure the tractor and the trailer against rolling.
23. Do not drive with the lifted load body.
24. When raising the load body, maintain a safe distance from power lines. The C.2.30. sign acc. to PN-ISO 11684:1998 on the front wall of the trailer warns of power lines.
25. During all servicing or repair works which require lifting the load body, the body must be empty and secured with the mechanical support against accidental falling.

26. Always adapt your driving speed to the conditions. Avoid rapid turns when driving uphill or downhill.
27. Maintain a safe distance from the U-turn range of the tractor and trailer train.
28. Ensure adequate visibility (with the help of a signalling person, if necessary) when driving in reverse.
29. Mind the inertia of the trailer when cornering.
30. Additional protection for the load transported on the trailer (chains, tarpaulin, plastic sheet, nets, transport straps, etc.) may be applied only with tractor engine off and the ignition key removed.
31. Remove functional disturbances of attachments only with the engine turned off and the ignition key removed.
32. Enter the load body surface only after turning off the drive and stopping the tractor engine. Remove the ignition key.
33. Always turn off the engine and remove the ignition key before exiting the tractor. Engage the parking brake and secure the trailer with the wheel chock.
34. When travelling on public roads, the permissible front and rear axle load of the T710/1 trailer must not exceed 40 kN each, while the permissible front and rear axle load of the T710/2 trailer must not exceed 51 kN each.
35. The maximum permissible pressure of the hydraulic system is 16 MPa.
36. The maximum permissible pneumatic pressure of the single-line system is 0.63 MPa or 0.8 MPa for the two-line system.
37. Prepare the trailer for work (connect the pneumatic and hydraulic hoses, etc.) with the tractor engine off and the ignition key removed.
38. The manufacturer delivers the trailer completely assembled.
39. All hydraulic lines must be replaced every 6 (six) years.
40. Noise — the equivalent sound pressure emission corrected by A characteristics (LpA) does not exceed 70 dB.

2.3.2. TYRES

1. Make sure to secure the trailer against accidental movement when servicing the tyres.
2. The wheels and tyres shall be repaired by trained personnel with adequate tools.
3. Regularly check the tyre pressure. Maintain the recommended pressure values.
4. Protect the tyres against sunlight during prolonged parking of the trailer.
5. Replace the wheels with the trailer empty, if possible.

2.3.3. PNEUMATIC SYSTEM

1. The pneumatic system is under high pressure.
2. When connecting the pneumatic lines with the pneumatic system of the tractor, ensure that the valves on the tractor and the trailer are depressurised.
3. Periodically inspect the pneumatic connections. Replace all damaged and aged parts immediately. Replace the lines as recommended in the manufacturer's technical requirements. Replace hoses every 5 (five) years unless damage is found earlier.
4. Before attempting any work on the pneumatic system, depressurise it and turn off the tractor's engine.
5. All repair work on the pneumatic system may only be performed by specialist services of the trailer's manufacturer.

2.3.4. PERIODIC MAINTENANCE

1. All maintenance, repair and cleaning operations, as well as troubleshooting must be performed after turning the drive and the tractor engine off. Remove the ignition key.
2. Inspect all bolts and nuts periodically and retighten if necessary. Replace regular bolts only with the bolts of the same quality and strength ratings.

3. When servicing under the lifted and tipped but unloaded load body, always secure the body with the support supplied with the trailer.
4. Use proper tools and safety gloves when replacing any parts.
5. After completing your work, thoroughly clean the trailer to leave no remains of the load on the body.
6. Before arc welding and/or working on the electrical system, isolate the continuous electrical power supply.
7. The safety/protection equipment wears out, which requires periodic adjustments, inspection and replacement when necessary.
8. Use only the original spare parts recommended by METAL-FACH Sp. z o.o. Sokółka.
9. Store the trailer in sheltered areas (preferably on level and hardened ground) and in a manner which prevents injuries of people and animals.
10. Release all worn out parts to authorised recycling points while following all applicable environmental protection requirements.

2.3.5. TRAVELLING ON PUBLIC ROADS

Before driving, check that the trailer lighting is working and that the trailer identification is complete.

Follow the traffic code regulations when travelling on public roads.

- Exceeding the permissible payload and driving speed may damage the trailer and compromise traffic safety.
- Do not exceed the permissible driving speed of 40 km/h.
- The trailer is designed for operation at maximum grades of 80°.
- When travelling on public roads, the trailer must feature a reflective warning triangle, and the slow-moving vehicle sign in the trailer bracket located on the chassis frame rear crosspiece (included with the trailer).
- Do not leave the loaded trailer on slopes and when it is not secured against rolling. Secure the trailer by engaging the parking brake and











chocking the wheels. Also bind the transported load with transport straps.

- The maximum transport (transit) speed is 30 km/h.

2.4. WARNING/INFORMATION SIGNS AND TEXT ON THE TRAILER

The warning signs and messages on the trailer must not be removed. They are intended for safe handling of the trailer. If any information label is damaged or removed, order a spare one. Text and symbol label stickers are available from service agents or the trailer's manufacturer.

GENERAL SAFETY RULES

Item	Safety symbol (sign)	Meaning of the symbol (sign) or text	Location on the machine
1.		Read the manual	On the load body's front wall
2.		Turn off the engine and remove the ignition key before servicing or repairs	On the load body's front wall
3.		Keep a safe distance from power lines	On the load body's front wall
4.		Do not reach into the crushing area if the parts may move	On side walls
5.		Install the support before entering the hazardous area	On the chassis side frame beam, at the support
6.		Do not ride on the machine – use the passenger seat only	On the load body front wall
7.		Keep a safe distance from the machine	On the load body's front wall
8.		Do not stand on ladders and platforms while the tractor is moving	At the ladder
9.		Feet (toes) crushing hazard. Force applied from above	At the support
10.		Lifting point	On the chassis frame side members
11.		Note! Do not perform any checks or servicing under the loaded or tilted load body without the support.	At the support

12.		Note! Do not remain within the range of discharged loads. Do not enter the trailer when it is hauled.	On the load body's front wall
13.		"Load capacity 6 t"	On the load body left and right wall
14.		"Load capacity 8 t"	On the load body left and right wall
15.		Maximum hydraulic system pressure: 16 MPa	On the floor front crosspiece
16.		Maximum pneumatic system pressure <ul style="list-style-type: none"> • 0.6 MPa, single-line system • 0.8 MPa, two-line system 	On the load body front wall
17.		"710 kPa" — 10.0/75-15.3 18PR tyres (MITAS)	Over the wheels
18.		"540 kPa" — 11.5/80-15.3 16PR tyres (MITAS)	Over the wheels



NOTE!

The trailer user is required to keep the warning symbols and text on the trailer legible during its entire operating life.

If damaged or destroyed, replace with new ones.

3. TECHNICAL CHARACTERISTICS, GENERAL DATA

Item	Contents		
I General data			
1.	Vehicle type	farming truck trailer	
2.	Manufacturer	METAL-FACH Sp. z o.o. 16-100 Sokółka, ul. Kresowa 62	
3.	Type (model)	T710	
4.	Body type	platform	
5.	Nameplate location	chassis frame front crosspiece	
6.	S/N stamping location	on the nameplate and underneath	
II Dimensions and weight			
		T710/1 — 6T	T710/2 — 8T
7.	Length, mm	6200	6200
8.	Width, mm	2250	2250
9.	Height (w/top section), mm	1645 (2145)	1780 (2280)
10.	Number of axles, pcs.	2	2
11.	Wheel track, mm	1700	1700
12.	Wheel base, mm	2840	2840
13.	Loading room size		
	- length, mm	4195	4195
	- width, mm	2130	2130
	- height (w/top section), mm	500 (1000)	600 (1100)
14.	Loading surface height, mm	1150	1295
15.	Tow bar oscillation height, mm	800	800
16.	Tow bar hitch-ring diameter, mm	40	40

17.	Vehicle ramp clearance, mm	320	320
18.	Vehicle kerb weight, kg	2000	2200
19.	Permissible vehicle overall weight, kg	8000	10200
	- front axle, kg	4000	5100
	- rear axle, kg	4000	5100
20.	Maximum axle load, k	N	
	- front, kN	40	51
	- rear, kN	40	51
21.	Permissible load capacity, kg	6000	8000
III Suspension			
22.	Suspension type	dependent, with springs	dependent, with springs
23.	Spring component type and style	7-leaf semi-elliptic spring with stop	7-leaf semi-elliptic spring with stop
IV Wheels and tyres			
24.	Number of wheels, pcs.	4	4
25.	Wheel disk size	14.00x15.3	14.00x15.3
26.	Tyre size, PR number, manufacturer, tyre pressure [bar]	10.0/75 - 15.3 14PR, (MITAS), [7.1] 11.5/60 - 15.3 16PR, (MITAS), [5.4]	11.5/80 - 15.3 16PR, (MITAS), [5.4] 12.5/80 - 15.3 14 PR. (TRELLEBORG), [4.0]
V Braking system			
27.	Service brake;		
	- type	mechanical, drum-type	mechanical, drum-type
	- control	pneumatic, positive pressure, two-line brake system (single-line system available on request)	pneumatic, positive pressure, two-line brake system (single-line system available on request)

TECHNICAL CHARACTERISTICS, GENERAL DATA

	- no. of wheels operated	4 wheels	4 wheels
28.	Parking brake		
	- type	mechanical, drum-type	mechanical, drum-type
	- control	manual, by a screw gear	manual, by a screw gear
	- operated components	2 rear axle wheels	2 rear axle wheels
VI Electrical system			
29.	Voltage rating, V	12 V, feed by the driving tractor	12 V, feed by the driving tractor
VII Operating data			
30.	Maximum speed, km/h	40	40
32.	Maximum transport speed, km/h	30	30
VIII Additional Information			
33.	Other information:		
	tractor hitch coupling	upper transport hitch	upper transport hitch
	driving tractor	40 kW minimum	40 kW minimum

4. GENERAL DESCRIPTION OF DESIGN AND FUNCTION

The T710 is a metal design with open load surface. The trailer features a pneumatic service brake and a parking brake that is manually operated via a screw gear, actuating the friction components of the rear axle service brake.

The trailer features a complete signalling and warning system (an electrical system and reflective lights).

The trailer is also suitable for transport on public roads.

The trailer is manufactured in accordance with:

- Directive 2006/42/EC
- and the following standards:
- PN-EN 1853+A1:2009E
 - PN-EN ISO 4254-1:2009E
 - PN-EN ISO 13857:2010P
 - PN-EN ISO 12100:2012P.

4.1. CHASSIS

The trailer chassis is composed of the following subassemblies: bottom frame, turntable frame, turntable, tow bar, wheel sets and suspension components. The bottom frame, the turntable frame and the tow bar are welded structures made of steel sheet and profiles.

The trailer wheel sets are composed of: the axles (front and rear), land wheels and wheel brakes.

The axles are made of thick-wall pipes terminated with plugs on which land wheel hubs are set by cone bearings. They are single wheels equipped with drum brakes with the shoes actuated by mechanical expander cams.

The trailer axle suspension consists of steel semi-elliptic leaf springs attached to the turntable frame and the bottom frame by pins and sliders. The wheel sets are attached to the springs by bolts.

4.2. LOADING SPACE

The loading space of the trailer is made up by the following elements: The top frame (box frame) that is set on the bottom frame (chassis frame) in articulated seats secured by pins which serve as pivots during tilting (tipping) of the top frame (load body/box).

The side walls/boards and their top sections are singular components. Each component features a separate set of locks for closing and opening of individual wall and top sections independently of each other and in any order. These design solutions increase functionality and facilitate operation of the trailer.

The wall and top section locks are secured against accidental release.

4.3. LOAD BODY HYDRAULIC TIPPING MECHANISM

The hydraulic mechanism is designed for automatic unloading of the trailer by tipping the load body backwards or sideways. The hydraulic tipping system is fed with oil from the tractor hydraulic system.

The hydraulic system includes: the coupling valve plug, hydraulic lines, a single-action hydraulic actuator, a cut-off valve, and connecting and fastening components. Figure 1 shows the diagram of the load body hydraulic tipping system. The lifting and lowering of the load body is controlled by the DCV in the tractor's hydraulic system.



NOTE!

* The cut-off valve limits the load body tilt angle during tipping to the sides. The valve is pre-adjusted by the trailer manufacturer. Do not adjust it on your own.

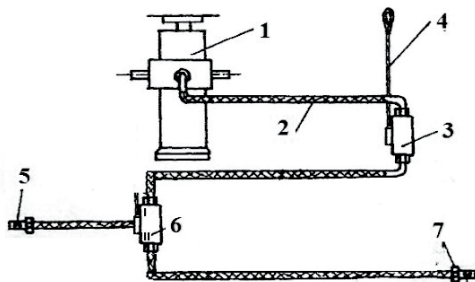

Fig. 1 Diagram of the load body hydraulic tipping system:
 1 – hydraulic actuator; 2 – hydraulic lines; 3 – cut-off valve; 4 – cut-off valve control cable;
 5 – coupling valve plug, 6 – control valve; 7 – coupling valve socket.

4.4. ELECTRICAL SYSTEM (SIGNALLING AND WARNING)

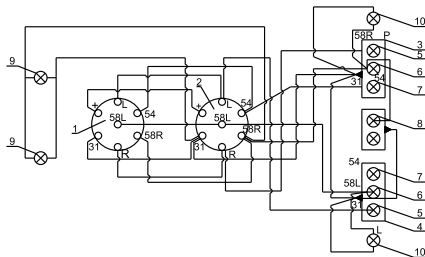

Fig. 2 Trailer's electrical system diagram
 1 – 7-pin plug; 2 – 7-pin socket; 3 – right tail cluster lamp; 4 – left tail cluster lamp; 5 – turn indicator light bulbs; 6 – tail parking light bulbs; 7 – stop light bulbs; 8 – registration plate light bulbs; 9 – front parking light bulb; 10 – outline marker lamp.

4.5. BRAKING SYSTEM

The T710 trailer is equipped with the following braking systems:

- service brake: pneumatically actuated, two-line system (or single-line on request), operates all wheels, controlled from the driver's seat by pressing the tractor's brake pedal;
- parking brake: mechanical control by hand via a crank lever mechanism and a screw gear, located on the left side of the trailer and operating the rear tandem axle wheels.

The service brake design ensures automatic braking of trailer land wheels if the pneumatic system is accidentally decoupled between the trailer and the tractor.

The single-line and double line pneumatic system diagrams are shown in the following figures.

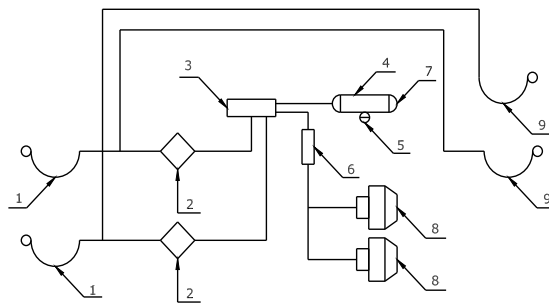

Two-line pneumatic system diagram
 1 – 1st trailer pneumatic connector; 2 – air filter; 3 – control valve; 4 – air tank; 5 – water drain valve; 6 – manual braking force control; 7 – check connector; 8 – pneumatic membrane actuator, 9 – 2nd trailer pneumatic connector.

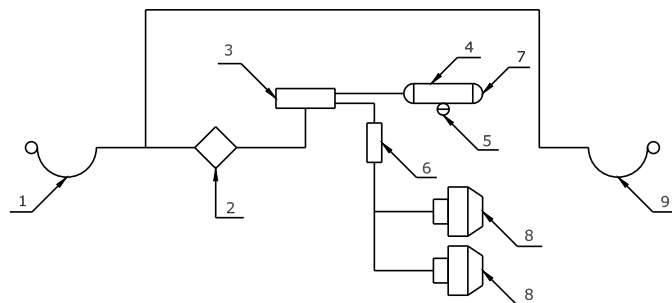

Single-line pneumatic system diagram

1 - 1st trailer pneumatic connector; 2 - air filter; 3 - control valve; 4 - air tank; 5 - water drain valve; 6 - manual braking force control; 7 - check connector; 8 - pneumatic cylinder, 9 - 2nd trailer pneumatic connector.

5. STORAGE, SALE AND SHIPPING TO USER

5.1. STORAGE

- Protect the trailer against direct exposure to sunlight and rain. Park it with its land wheels chocked on a hard-paved ground (reduce tyre pressure and cover the tyres if there is a risk of exposure to sunlight).
- If the trailer is exposed to weather, periodically check for rainwater accumulation in the trailer. Note all damage to the paint coat. Clean and degrease spots of damaged paint. Next, repaint with the same colour and coat thickness.
- Long-term storage is allowed in sheltered rooms only.

5.2. SALE

- The buyer picks the trailer from the manufacturer or the sales representative on their own, or arranges the delivery with the manufacturer.
- The trailer is sold as fully assembled and ready for operation, complete with the basic equipment listed in section 1.2 of this manual. Optional equipment is available for extra charge.
- The sales representative personnel is required to introduce the buyer to the design and operation of the trailer, along with safety requirements and warranty conditions.
- The buyer shall verify the following:
 - The trailer is complete, undamaged and with all basic equipment;
 - The nameplate located on the chassis front crosspiece has the serial number stamped that matches the data in the warranty card;
 - The warranty card has been properly filled out with the identification data on the nameplate.

5.3. SHIPPING TO USER

The trailer shall be transported from the sales representative on wheels as coupled with a tractor or on a low-bed trailer. Before loading on a low-bed trailer, connect the farming trailer with the transport hitch and the braking lines of the tractor. Place the farming trailer on the low-bed trailer using the extended ramps. Next, secure the farm trailer with wheel chocks. Afterwards, disconnect the braking system and decouple from the tractor. Secure the farming trailer with special transport straps. Before unloading the transported trailer, extend the low-bed trailer ramps and release the transport straps used to secure the farming trailer from falling down in transit. Approach with a tractor and connect the trailer braking system's cables. Next, remove the chocks from underneath the trailer's wheels. When all of the above has been completed, move the trailer off the low-bed.

6. OPERATION INFORMATION

6.1. COMMISSIONING THE TRAILER

	*Use only tractors that are fit for service (with the transport hitch, the pneumatic system and the signalling/warning system working)
IMPORTANT!	

Do the following before commissioning the trailer:

- Understand the names and locations of individual assemblies/components of the trailer.
- Check the tyre pressure.
- Couple the trailer with the tractor:
 - set the tow bar hitch-ring of the trailer at the trailer transport hitch height;
 - couple the hitch-ring with the trailer hitch;
 - secure the hitch pin against falling out;
 - turn off the tractor's engine;
 - engage the tractor's parking brake;
 - connect the appropriate sockets and plugs of the pneumatic and electrical systems;
- do the functional checks of the electrical, pneumatic and hydraulic systems of the tractor and of the trailer, and check leak tightness of the hydraulic and pneumatic systems on both vehicles;
- check all equipment, the connections and safety from accidental release or misalignment;
- release the trailer's parking brake.

Perform all these actions each time before working with the trailer.

	Couple the trailer with the tractor's upper hitch only. No bystanders shall remain between the trailer and the tractor when the two are being coupled.
NOTE!	

6.2. LOADING THE BODY

Load the body only when the trailer is coupled with the tractor, parked on level ground and with the tow bar in the forward driving direction. Use mechanical loading equipment (cranes, loaders, conveyors, etc.) to load the trailer.

Make sure that all wall and top section locks are engaged before loading the trailer.

Spread the load evenly across the entire load body surface. When transporting materials that exert focused (topical) pressure on the load body (e.g. large rocks), line the floor with thick planks first. This will reduce the surface load on the floor and protect it against damage.

When transporting large volume materials, install the top sections of the load body walls. If the transported materials protrude from the trailer, follow the applicable traffic code regulations for proper marking of protruding loads.

	<ul style="list-style-type: none"> • Do not exceed the permissible payload and permissible axle loads, otherwise the trailer can be damaged and the traffic safety compromised. • The transported load must be secured against shifting, generating excessive noise and falling down on the road.
NOTE!	

Approximate weight values of certain goods, 1 m³ = kg

Soil	1600–1800	Legumes	760–820
Wheat	710–820	Construction rubble/aggregate	1400–1850
Potatoes	625–725	Lime	900–1500
Sugar beets	650–700	Hard coal	1200–1600

6.3. TRAVELLING ON PUBLIC ROADS

Before entering a public road, do the actions listed in section 6.1 and also the following:

- Install the slow-moving vehicle sign on the trailer;
- Ensure that the transported load is secured with straps from falling down on the road;
- Check that the load does not exceed the permissible capacity or axle load;



NOTE!

- Follow the traffic code regulations.
- In the first operating hours of the brakes, the drum brake shoes align themselves with the drums. The full braking effectiveness is achieved once the friction parts have run in.



Fig. 4. Location of the bracket for the slow-moving vehicle sign

6.4. UNLOADING

The load body can be unloaded manually, with mechanical equipment or by tipping the box with the hydraulic mechanism. Unload by tipping the load body by following these actions in the order presented below:

- Align the tractor with the trailer's axis;
- Engage the tractor's parking brake;
- Remove the safety pin that couples the load body with the chassis frame (fig. 5):
 - If unloading to the back – the pins (fig. 5) must remain in the rear bells of the load body;
 - If unloading to the left – the pins must be installed in the left hand bells;

- If unloading to the right – the pins must be installed in the right hand bells;
- Make sure that the pins on the side to which the trailer is to be unloaded have been properly installed;
- Open the body wall locks on the unloading side;
- Tip the load body by operating the hydraulic actuator;
- After the load has been discharged, lower the body and secure the wall(s) with the locks.



NOTE!

- If it is necessary to unload the trailer on a slope, it is allowed to tip the trailer body upwards (with the tractor and the trailer parked in the uphill direction).
- No person is allowed to remain near the tipped trailer body and within the range of discharged load.
- Do not decouple the trailer from the tractor when the load body is lifted.
- Before unloading by tipping the trailer load body, you must always verify that the pins have been removed on the correct side of the trailer. Failure to remove the pins may destroy the trailer!
- Do not transport any persons on the trailer.

Open the top lock of the load body by moving the handle up and depressing the button under the handle at the same time.
 Open the bottom locks of wall segments by operating the central lock handle:

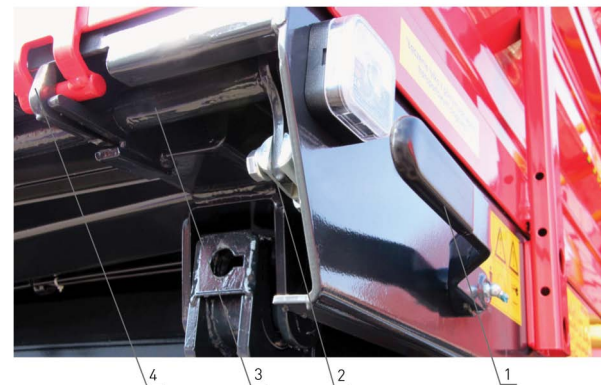
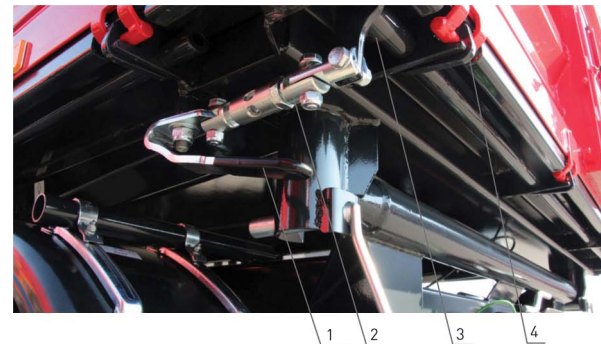

Fig. 5. Load body wall locks
 1. central bottom lock handle; 2. lock adjustment mechanism; 3. central lock shaft; 4. lock

Having discharged the load from the trailer, do the following:

- Lower the load body and remove all remains of the transported material;
- Install and secure the pins that connect the load body with the chassis frame;
- Lock and secure the wall(s) against accidental opening.

6.5. DECOUPLING FROM THE TRACTOR

Do the following actions to decouple the trailer from the tractor:

- Stop the tractor with the trailer at the location where the latter will be left, and engage the tractor's parking brake;
- Engage the trailer's parking brake;
- If the trailer stands on an uneven or sloping ground, secure it against rolling down by chocking the wheels;
- Disconnect the electrical, hydraulic and pneumatic lines from the tractor;
- Remove the safety from the hitch pin and then remove the pin – this will decouple the tow bar from the hitch. Drive away with the tractor and reinstall the pin in the hitch.



NOTE!

Do not decouple the trailer from the tractor when:

- The load body is lifted;
- The trailer is not secured against rolling away.

7. SERVICING

7.1. SERVICING INSTRUCTION FOR ADJUSTED TRAILER COMPONENTS

In order to maintain proper performance, the T710 trailer requires the following adjustments:

- Adjustment of the wheel bearing clearance;
- Adjustment of the braking system components.

7.1.1. WHEELS – BEARING CLEARANCE ADJUSTMENT

During the first operating hours of a newly purchased trailer (i.e. after approximately 100 km of mileage) and further operation (i.e. after the next 1500 or 2000 km), check the wheel bearing clearance and adjust, if necessary.

To do so:

1. Couple the trailer with the tractor and engage the tractor's parking brake.
2. Jack up one side of the trailer to lift the wheel from the ground on this side and secure it against falling.
3. If the wheel has excessive clearance, remove the hub cap and remove the crown nut clevis pin.
4. Rotate the wheel and tighten the crown nut at the same time until the wheel stops turning.
5. Loosen the crown nut by 1/6 to 1/3 of the full turn, i.e. until the nearest clevis pin groove is aligned with the hub pivot hole.
6. Secure the nut with a new clevis pin, and reinstall and retighten the hub cap.

After a correct adjustment of bearing clearance, the wheel should rotate smoothly, without cogging or evident resistance (not caused by rubbing of the brake shoes against the drum).

Slight rubbing of the shoes against the drum, especially on a brand new trailer or following replacement of the shoes is normal. Do the final check of proper bearing clearance adjustment by travelling several kilometres

and inspecting the hub heating by hand. Apart from incorrect clearance adjustment, significant rolling resistance of the wheels and heating of the hubs can also be caused by contaminants in the grease or damage of bearings. These symptoms require removal of the wheel hub to be corrected, if found.

**NOTE!**

Follow these rules when jacking up the trailer wheel:

- Couple the trailer with the tractor, move to level ground and engage the tractor's parking brake;
- Chock the wheel that is not being jacked up;
- Place the jack under the axis and near the jacked up wheel, and lift the wheel so that it clears the ground;
- Secure the wheel against falling by putting a prop of suitable height under the axis.

7.2. BRAKES

7.2.1. SERVICING THE BRAKE PNEUMATIC SYSTEM

When servicing the trailer, check the tightness and the condition of parts and connections of the braking system, and periodically drain the water condensate from the air tank.

Check the leak tightness of the system at the rated pressure of approx. 800 kPa for the two-line system. Leaks are detected by a distinct hiss or air bubbles (after coating with soapy water) at the points of air escape from the system. If the leaks are caused by damaged seals, lines or other parts (valves, actuators, etc.), replace them.

Drain the water from the air tank by tilting the drain valve stem to the side when the tank is pressurised; the drain valve must also be unscrewed from the tank and cleaned of accumulated dirt once a year, before the winter season.

7.2.2. ADJUSTMENT OF THE BRAKING SYSTEM COMPONENTS

When servicing the trailer, check the condition of parts and connections of the braking system, and periodically inspect the lubrication of control elements.

Adjust the brakes when the following occurs:

- There is an excessive clearance between the shoes and the drum from the brake shoe wear, resulting in decreased braking performance;
- The wheel brakes work unevenly and out of sync.

With the properly adjusted brakes, the braking force (i.e. the total of braking forces at the circumference of the wheels) shall be at least 27% of the permissible total weight of the trailer when decelerating with the service brake; the braking force (i.e. the total of braking forces at the circumference of the wheels) when actuating the parking brake shall be at least 16% of the permissible total weight of the trailer. Both wheels on the same axle should be stopped evenly; the brake force differential between the left and right trailer side shall not exceed 30%, with 100% being the higher force.

Park the trailer so that the rear wheels rotate freely. Loosen the nut (4) so that the arm (2) is able to move against the shaft (1). Retighten the nut (4) when the position of the shaft (1) against the arm (2) results in a slight rubbing of the brake shoes against the drum while turning the wheel. Repeat for the other wheel.

After the correct adjustment of friction components, the wheel should rotate smoothly, without cogging or evident resistance (other than caused by rubbing of the brake shoes against the drum). Slight rub of the shoes against the drum, especially on a brand new trailer or following replacement of the shoes is normal.

After completing the adjustment, check and adjust the parking brake. The parking brake is adjusted by setting the cable length that couples the expander shaft lever with the engaging mechanism. The required sum

of braking forces should be produced at the maximum force applied to the hand crank of 40 daN [at the right angle between the cable and the expander shaft lever].



	<p>Regularly inspect all braking components before driving for:</p> <ul style="list-style-type: none"> • Proper operation; • Tightness (seal); • Play; <p>and readjust or repair as necessary.</p>
<p>NOTE!</p>	



Fig. 6. Braking system components:
 1 – brake shoe expander shaft; 2 – expander shaft lever (arm); 3 – arm adjusting comb on the expander shaft; 4 – lever adjustment nut on the expander shaft; 5 – the link (follower) that couples the pneumatic actuator rod with the expander shaft lever; 6 – parking brake cable; 7 – membrane actuator.

	<ul style="list-style-type: none"> • Inspect the brake shoes at least each year. Replace worn shoes. • In order to achieve the required braking performance after replacement of friction components, remember to run them in (by driving with frequent braking), which should be followed by readjustment.
<p>IMPORTANT!</p>	

7.3. WHEELS – TYRES

Servicing of the tyres involves checking their condition visually and checking the tyre pressure. It is also essential to check that the tyres have no cracks that expose or damage the carcass, and that the hubs, wheel disks and their fastening are in good condition.

	<ul style="list-style-type: none"> • Regularly inspect the wheel nuts (i.e. the condition and tightness before each use of the trailer); retighten if necessary. • Regularly inspect the wheel nuts (i.e. the condition and tightness before each use of the trailer); retighten if necessary.
<p>NOTE!</p>	<ul style="list-style-type: none"> • Nut tightening torques for different thread sizes: <ul style="list-style-type: none"> • M18x1.5 = 270 Nm. • M20x1.5 = 350 Nm. • M22x1.5 = 475 Nm.

	<p>After the first drives with loads and after each 100 km, inspect the following:</p> <ul style="list-style-type: none"> • The tightness of wheel nuts; retighten if necessary. • The tyre pressure. The correct tyre pressure is displayed near the trailer wheels • applies to transport at the maximum permissible speed (at the maximum payload).
IMPORTANT!	

7.4. HYDRAULIC SYSTEM

7.4.1. SERVICING OF THE LOAD BODY HYDRAULIC TIPPING SYSTEM

The hydraulic oil of the trailer and the external hydraulic system oil (tractor) must always be of the same grade and type. DO NOT use different oil grades. The trailer's hydraulic system must be absolutely leak tight. Check the leak tightness of the hydraulic system by tipping the load body backwards and overloading the hydraulic system for a few seconds. If there are oil leaks at the hydraulic connections, retighten them. If the problem persists, replace the hose or the connection fittings. If the hydraulic leak does not occur on any connector, replace the leaking hydraulic system component. Any and all mechanical damage to a component requires its replacement with the new one. The condition of the hydraulic system must be monitored continuously throughout the operating life of the trailer. When coupling the hydraulic systems of the tractor and of the trailer together, keep the couplings as clean as required.

7.4.2. SERVICING OF THE LOAD BODY HYDRAULIC TIPPING SYSTEM

The hydraulic system features a safety cable (which acts as a tipping angle limiter of the load body) and the cut-off valve that isolates the oil flow to the hydraulic actuator when the body is tipped. No unauthorised persons are allowed to make adjustments or remove the limiters due to safety concerns. The cut-off valve is intended to isolate the oil feed from the actuator before the maximum (permissible) tipping angle of the body is reached. Changing the length or breaking the cable between the load body frame and the cut-off valve may result in damage of the trailer or a risk of turning over the trailer.

	<ul style="list-style-type: none"> • Do not remove or disconnect the safety cable / load body tipping limiter. • Unauthorised persons must not adjust the cut-off valve.
NOTE!	

8. TROUBLESHOOTING

Table 3 lists the faults, their causes (symptoms) and solutions.

	Fault type	Possible cause	Remedy
1.	Excessive heating of brake drums	Brake shoes are out of adjustment	Adjust per section 6.2.2.
2.	Excessive heating of wheel hubs	Insufficient clearing of bearings. Contamination in bearing grease	Adjust per section 6.1.1. Remove the hub, replace the grease and adjust the bearings as indicated above.
3.	The grease flows out on the brake shoes	Damaged, worn out or improperly installed hub seal	Remove the hub, replace the worn/damaged seal and reinstall properly. Remove the grease from shoes and brakes, clean the friction components with extraction naphtha, reinstall the hub and adjust the bearings as indicated above.
4.	Uneven braking of wheels	Contamination or excessive wear of shoe pads, or the brake shoes are out of adjustment.	Check the brake shoe pads, remove contaminants, replace worn out pads and readjust as in section 6.2.2.
5.	Insufficient wheel braking performance.	Incorrect adjustment of the shoes and brake controls.	Adjust the brake shoes and control components per section 6.2.2.
6.	Oil leak at the hydraulic connections	The connectors are made too loose or damage of connector seals.	Retighten and/or replace the line parts as necessary.
7.	Oil leak from the cut-off valve or the actuator.	Worn out or damaged seals, or mechanical damage of devices.	Replace the seals or the entire devices (units).
8.	The load body locking pin does not engage the seat.	The pin is bent or there is dirt between the pin and the casing.	Replace the pin or clean the pin and casing, apply a thin coat of grease on the pin, install it in the seat and secure the pin.
9.	The load body support seat is misaligned with the chassis frame plug.	The chassis frame or the load body frame is bent, or there is mechanical damage of the mating components.	Notify the manufacturer to replace the damaged components

9. PERIODIC MAINTENANCE

9.1. LUBRICATION

Proper lubrication is one of the most critical factors that condition good performance of individual assemblies and mechanisms of the trailer. Compliance to the manufacturer’s guidelines for lubrication significantly reduces the risk of damage or premature wearing of individual parts.

Follow these rules when lubricating:

- Clean the grease nipple before feeding the grease;
- Feed the lubricant until fresh lubricant comes out of the gaps (through which the used lubricant is pushed out first);
- When finishing the lubrication, leave some lubricant on the nipple head;
- Use oil to lubricate threaded joints, lever joints and similar parts of the trailer;
- Inspect the lubrication of wheel hub bearings each year; add or replace the bearing lubricant;
- When replacing the lubricant, remove the hub, remove the used lubricant, inspect the bearings’ condition (replace with new ones if necessary); after applying the fresh lubricant, adjust the bearing play.

	<ul style="list-style-type: none"> • Use only quality bearing lubricants. • Never drive without the hub cap; otherwise penetration by dirt (sand) will damage the wheel bearings.
IMPORTANT!	

Lubrication point	Lubricant grade	Lubrication frequency
Wheel hub bearings	LT 43	Every 6 months
Hydraulic actuator head sockets	Graphite grease	Once a year
Load body tipping system parts	LT 43	Every 6 months
Eye catch	LT 43	Every 6 months

Other lubrication points:

- Regularly lubricate movable parts of locks, hinges and articulated joints.
- Pressure-feed the lubricant with a grease gun through clean nipples;
- Regularly lubricate movable parts of brakes (levers and pins).
- Lubricate the brake shoe axes only when necessary and only with a small amount of lubricant.

9.2. MAINTENANCE AND SERVICING

The transport capacity and long operating life of the farming trailer can only be achieved if the machine is properly and reasonably operated within its design and functional capacities.

Even a slight negligence in operation may result in severe consequences. A timely discovered fault is easy to remove at a minimum cost and effort, while producing the maximum effect.

Faults of the trailer can only be discovered soon if regular, periodic cleaning and thorough inspection is carried out.

Hence clean the trailer frequently to observe any damage and faults.

Also carry out periodic technical inspection of the trailer. Lubricate the trailer according to the guidelines for lubrication.

Store the trailer in a sheltered area to protect it from weather conditions and deterioration. In order to preserve its proper performance, the trailer must be maintained, readily repaired and thoroughly supervised during its operating life. Daily servicing (before work) of the trailer includes a certain minimum of actions, i.e.:

- check the screwed components and their safeguards from accidental release;
- check the play of mechanisms and articulated joints;
- check the tightness of the hydraulic system and remove all leaks;
- check the tightness of the pneumatic system;
- functional checks of mechanisms;
- check and perform lubrication according to the instructions;

- check the tyre pressure;
- check the wall locks for proper engagement and security;
- wall top sections in use: do functional tests and check that the parts do not pose risk to traffic safety and operator's safety;
- functional check of the brake system and the warning and signalling system.

Small repairs required by accidental faults must be carried out with care for cleanliness, installation of all parts at their locations and adjustments essential to proper performance of the trailer.

Small repairs during operation (in the field) shall be done on site by service personnel.

All parts removed during repairs shall be stored in conditions that protect from dust and other contaminants. Pay particular attention to protection and cleanliness of bearings.

During field repairs, keep the area clean when reassembling the parts (the parts which fell to the ground shall be washed or at least cleaned of dirt to an extent that permits proper functioning).

During running and general repairs, follow the engineering rules for disassembly and (re)assembly of parts and subassemblies to ensure proper quality and performance of work.

Do functional tests of trailer mechanisms after each repair.

10. DISPOSAL OF THE TRAILER

If the user decides to dispose of the trailer, hand over the entire vehicle to the nearest scrap collection point approved by local authorities. The proof of disposal issued by the collection point is essential for de-registration of the trailer. Recycle the parts which remain after repairs or have become obsolete.

11. RESIDUAL RISKS

11.1. DESCRIPTION OF RESIDUAL RISKS

METAL-FACH Sp. z o.o. is liable for the design and build in order to eliminate all hazards, some partial risk is unavoidable in operation of the trailer. The residual risk stems mostly from improper behaviour of the operator caused by lack of knowledge or attention. The greatest hazards occur during the following forbidden actions:

- The trailer is operated by minors or persons who are not licensed for tractor driving, or who are unfamiliar with the operating instructions.
- The trailer is operated by persons who are ill or under the influence of alcohol or other intoxicants.
- The trailer is used for purposes other than specified in the operating instructions.
- A person is present between the tractor and the trailer with the tractor's engine running.
- Bystanders, especially children are present near the working trailer.
- The trailer is cleaned while working.
- Manipulation of the driving unit on the tractor and the moving elements of the trailer while the machines are working.
- Checking the trailer's technical condition while it is running.

While presenting the residual risk the trailer is treated as designed according to the state of knowledge at the year of manufacture and maintaining the basic OH&S rules.

11.2. EVALUATION OF THE RESIDUAL RISK

Follow these guidelines:

1. Always follow the safety regulations described in the operating instructions.
2. Read and fully understand the operating instructions.
3. Keep your hands out of hazardous spaces.
4. It is forbidden to operate the trailer in the presence of bystanders,

this applies in particular to children.

5. Maintenance and repairs of the trailer shall only be performed by trained personnel.
 6. The trailer shall only be operated by persons who have been trained in its operation and have familiarised themselves with the operating instructions.
 7. The trailer is protected against access by children.
- Only then can you eliminate the residual risks to people and the environment when using this trailer.



NOTE!

The residual risks are present when the listed rules and indications are not followed.

12. WARRANTY CONDITIONS

1. The manufacturer provides a trailer designed and built in compliance with the current standards. The manufacturer guarantees that the supplied trailer is free of manufacturing defects.
2. Metal-Fach Sp. z o.o. provides 12-month warranty service for the trailer starting from the date of first sale, provided the trailer is used for its intended purpose and the recommendations contained in the manual are followed.
3. The warranty card properly filled in at the Dealership is the confirmation of the manufacturer's warranty; the acceptance of the warranty conditions must be confirmed by the customer's signature.
4. The quality warranty covers the machine defects caused by defective manufacturing, material defects and latent defects.
5. The warranty does not cover the assemblies and parts which are subject to normal wear and tear.
6. The warranty does not cover any mechanical damage or other damage resulting from improper use, improper maintenance or improper adjustment of the trailer.
7. The warranty does not cover any damage resulting from improper storage of the machine.
8. Any unauthorised modifications in the construction of the machine introduced by the user will result in automatic termination of the warranty.
9. The manufacturer shall not be held responsible for any loss, damage or destruction of a product resulting from causes other than defects of the supplied machine.
10. During the warranty period the manufacturer will repair any defects which occurred as a result of the manufacturer's negligence.
11. The warranty repair shall be made within 14 working days of the notification/supply of the trailer to the designated service station or at another time agreed upon by the parties.

12. The warranty is extended by the time required to complete the repair.
13. All repairs which are not covered by the warranty performed by authorised service stations are made at a full cost payable by the user. Before such repairs, the service station will inform the user of the suggested cost, time and scope of the repair.
14. The Customer makes the decision whether to commence a payable repair of the trailer with a warranty valid at the time of repair.



NOTE!

Current information about the products is available at www.metalfach.com.pl

METAL-FACH

16-100 SOKÓŁKA, POLAND

UL. KRESOWA 62

WARRANTY CARD

OF THE FARMING TIPPER TRAILER

T710

The warranty service is provided on behalf of the manufacturer by:

filled out by the seller

Date of manufacture	Date of sale
Serial number	Dealer's signature
Customer's name and surname		
Address		
		

NOTES

NOTES

SALES METAL-FACH®

16-100 Sokółka, ul. Kresowa 62
tel.: +48 85 711 98 44, fax: +48 85 711 07 89
handel@metalfach.com.pl

SUPPORT SERVICE METAL-FACH®

16-100 Sokółka, ul. Kresowa 62
tel.: +48 85 711 07 80, fax: +48 85 711 07 93,
serwis@metalfach.com.pl

SPARE PARTS & SHOP METAL-FACH®

16-100 Sokółka, ul. Kresowa 62
tel.: +48 85 711 07 81, fax: +48 85 711 07 93,
sklep.mff@metalfach.com.pl

METAL-FACH®

METAL-FACH Sp. z o.o. UL. KRESOWA 62; 16-100 SOKÓŁKA